

GB 902 / GB 1540 / GB 1555



GB Series



GB 902



GB 1540



GB 1555



Produttori automatici di ghiaccio a scaglie granulari.

Ghiaccio a granuli compatti per i diversi impieghi in bar, ristoranti, pescherie, industria chimica e farmaceutica.

Automatic granular ice flakers.

Compact granular ice for various different uses in bars, restaurant, fish-shops, chemical and pharmaceutical industries.

Machines à paillettes.



Glace en paillettes granulées pour usages dans les bars, restaurant, poissonneries, industrie chimique et pharmaceutique.





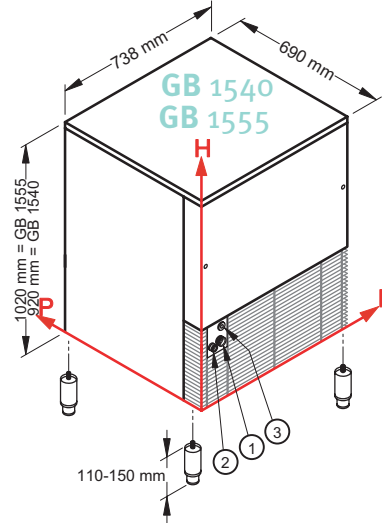
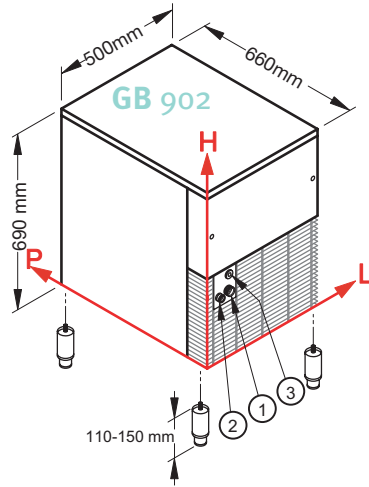



GB Series

GB 902 / 1540 / 1555

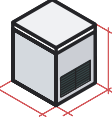
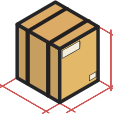

	1 			2 			3 		
	L	H	Ø	L	H	Ø	L	H	Ø
GB 902	99	158	3/4"	48	151	24mm	87	230	-
GB 1540	104	247	3/4"	53	240	24mm	92	319	-
GB 1555	104	247	3/4"	53	240	24mm	92	319	-

	Produzione in 24 h, sino a: Production in 24 h till: Production en 24 h jusqu'à:	Capacità contenitore Storage capacity Reserve	Raffreddamento Cooling System Condenseur	Refrigerante Refrigerant Fluide réfrigérant	Voltaggio Standard Standard Voltage Tension standard	Potenza assorbita Input power Puissance absorbée	Consumo acqua (l/kg) Water consumption (l/kg) Consommation d'eau (l/kg)	Dimensioni (LxPxH) Sizes (WxDxH) Dimension (LXPxH)	Dimensioni con imballo (LxPxH) Sizes with packing (WxDxH) Dimension (avec emballage) (LXPxH)	Peso netto/lordo Weight net/gross Poids net/brut
					V/Hz	W				
GB 902	90 Kg	20 Kg	A W	R404A	220-240/1/50	550 W	A W 1 6,3	mm 500x660x690	mm 550x710x805	59/67 Kg
GB 1540	150 Kg	40 Kg	A W	R404A	220-240/1/50	650 W	A W 1 6,4	mm 738x690x920	mm 780x735x1030	85/95 Kg
GB 1555	150 Kg	55 Kg	A W	R404A	220-240/1/50	650 W	A W 1 6,4	mm 738x690x1020	mm 780x735x1130	94/105 Kg

Finitura: acciaio inox 18/8, scotch brite - Finishing: 18/8 stainless steel, scotch brite - Carrosserie: inox 18/8, scotch brite.



Condizioni
Conditions
Conditions



UNI EN ISO 9001
Cert. N. 9130.BRE2



+21°C  +15°C 

Watt + 43°C  (230/1/50)

OHSAS 18001:1999
Cert. N. 9192.BRE3

			V / Hz	
Minimum	+10 °C	+3 °C	-10%	1bar (14psi)
Maximum	+43 °C	+32 °C	+10%	6bar (84psi)



www.bremaice.it
info@bremaice.it

VIA DELL'INDUSTRIA, 10

20020 VILLA CORTESE (MI), ITALY

TEL. +39 0331 434811
FAX +39 0331 433833